



Optics
Shinland

Each Ray is brighter in Shinland

SL-075B

Details

Material:	URC2500
Cover Material:	PC
Process:	Vaccum Aluminum Plating PC
MAX Diameter:	75.0mm
Height:	53.5mm
Matched Holder:	SL-HD-A
Matched Cover:	SL-075-CLEAR-LENS/SL-075-MIXING-LENS
ROSH Compliant:	YES
Status:	Ready

Optical Properties

Code	Typ. FWHM	Typ. Eff
SL-07518B	18°	91%
SL-07526B	26°	91%
SL-07538B	38°	91%
SL-07555B	55°	91%

Matched LED Source

CXM-18

Vero18
V15
V18 Gen6

1208

XTM-19

LC026B
LC033B

EDC-57C-30

Photo



Dimensional Figure

SL-075B

Measure Unit: mm

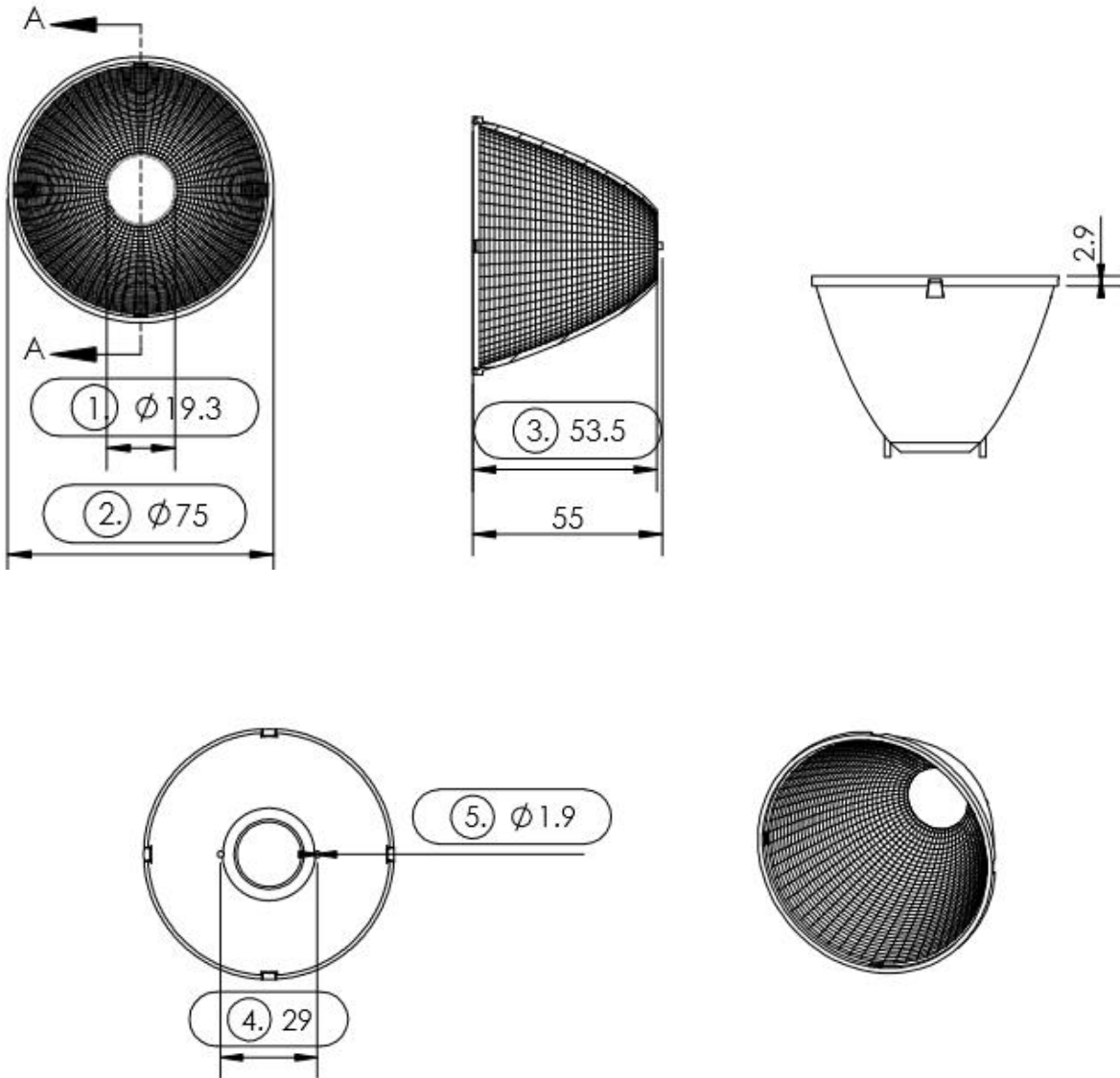

Dimensional Figure

SL-CXM-18-HD-A

Measure Unit: mm

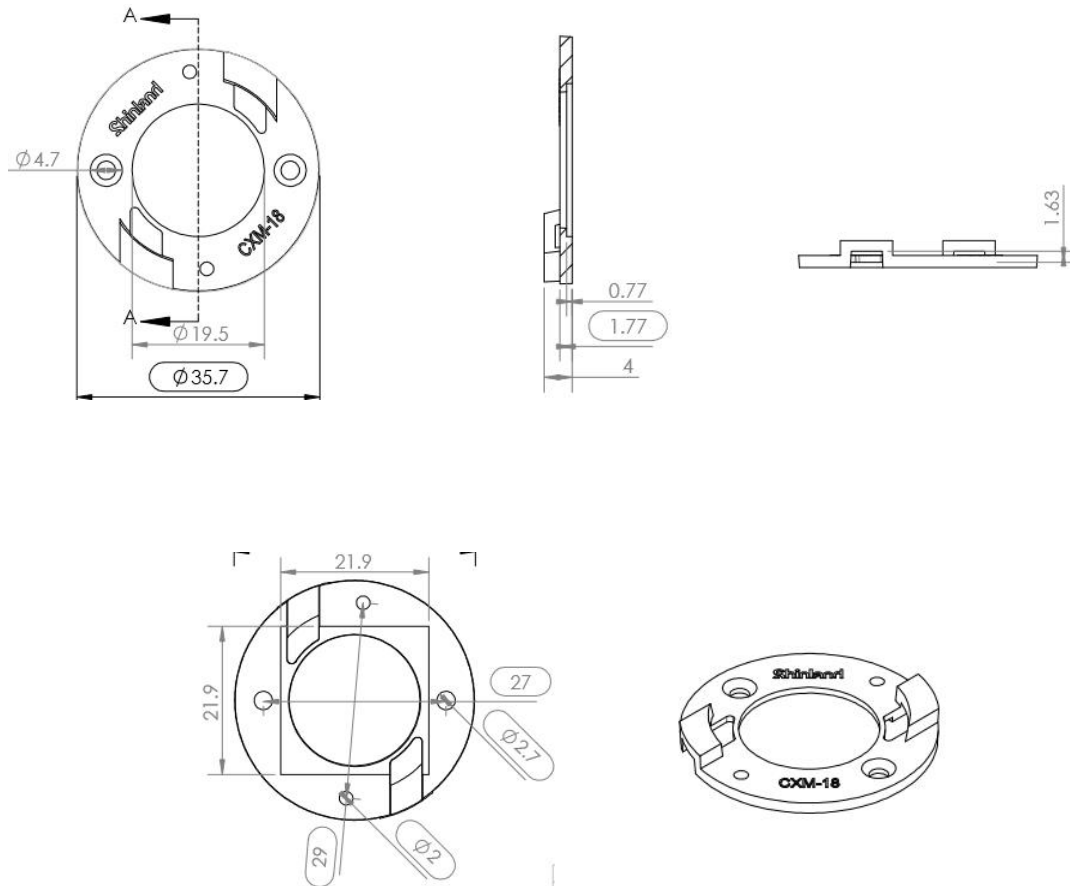

Distribution Curve Flux

SL-075B&SL-CXM-18-HD-A

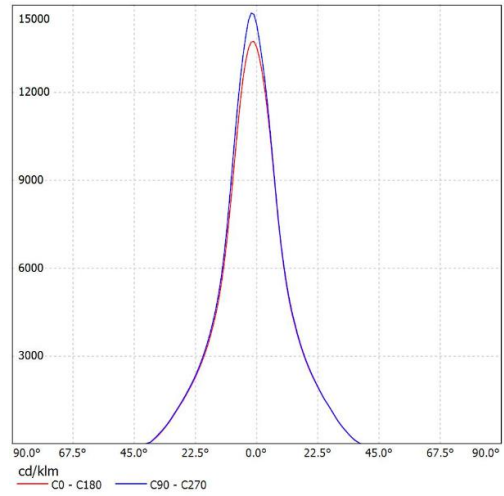
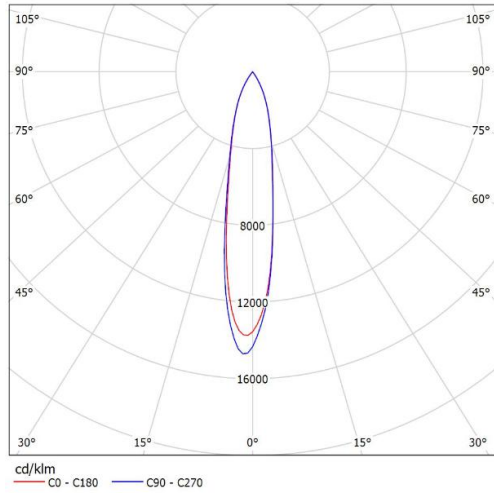

SL-07518B
K:4.69cd/lm,LED:CXM-18

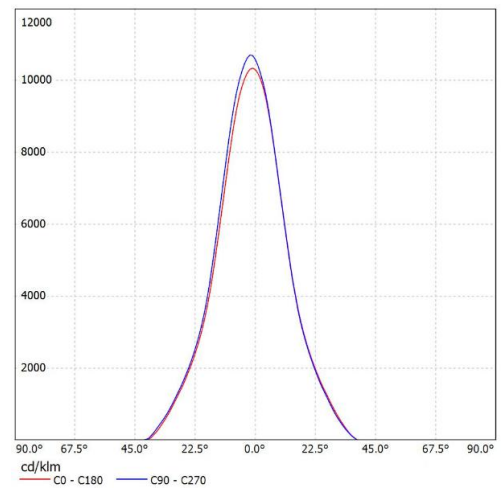
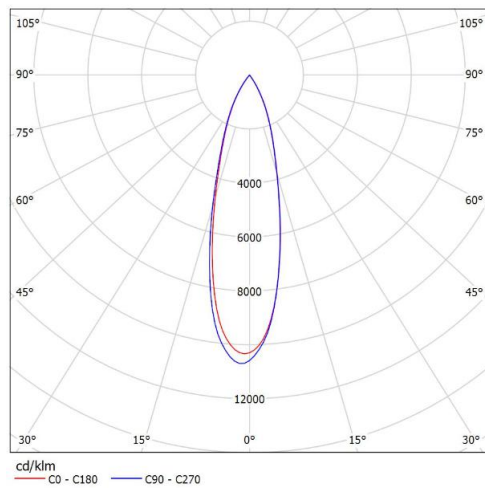

SL-07526B
K:4.40cd/lm,LED:CXM-18

Distribution Curve Flux

SL-075B&SL-CXM-18-HD-A

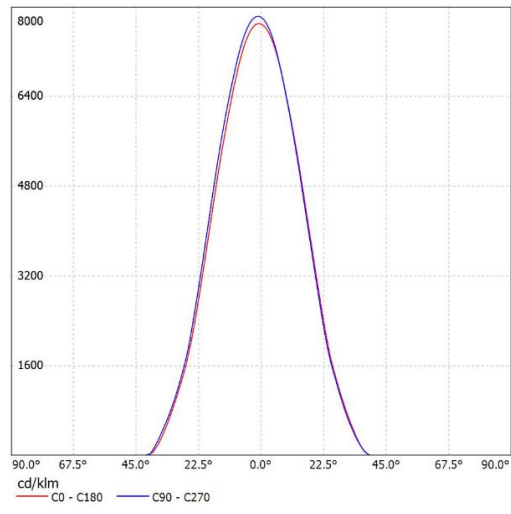
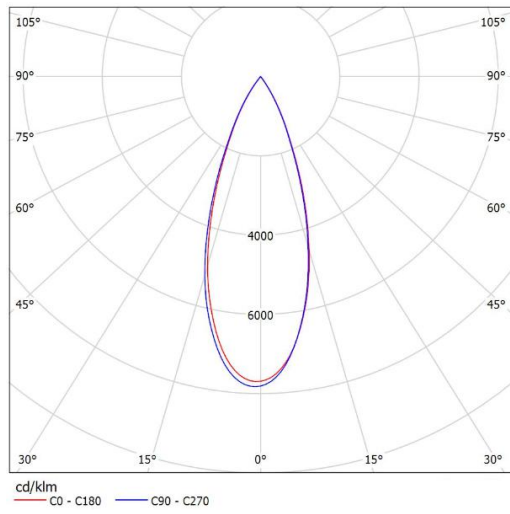

SL-07538B
K:2.46cd/lm,LED:CXM-18

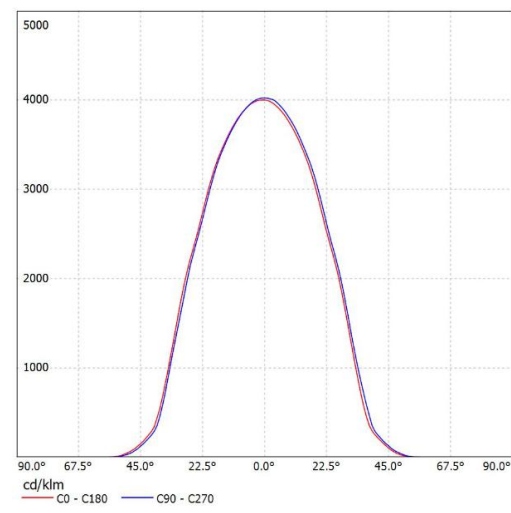
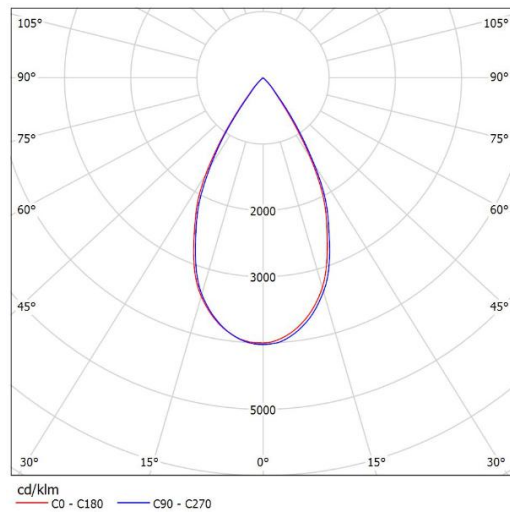

SL-07555B
K:1.33cd/lm,LED:CXM-18

Distribution Curve Flux

SL-075B&SL-CXM-18-HD-A

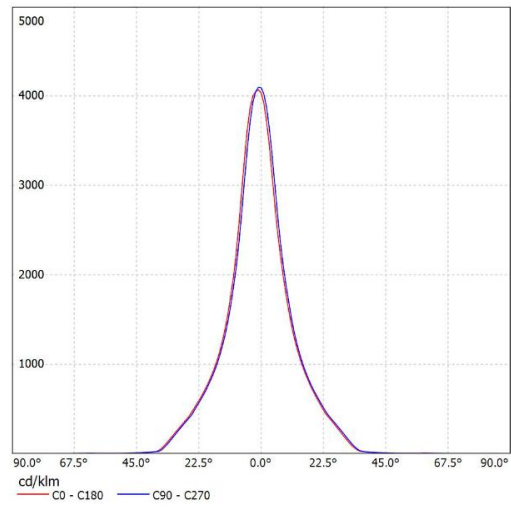
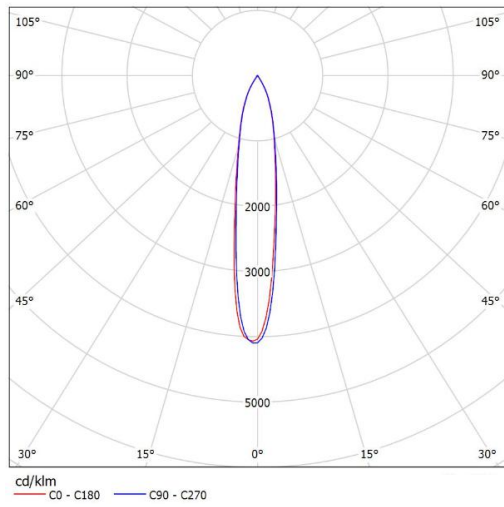

SL-07518B
K:5.00cd/lm,LED:V15

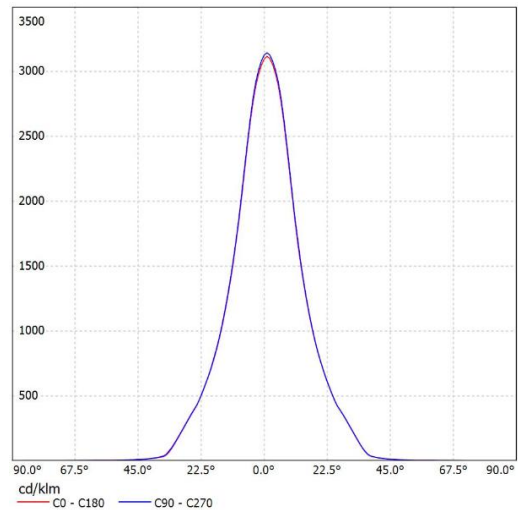
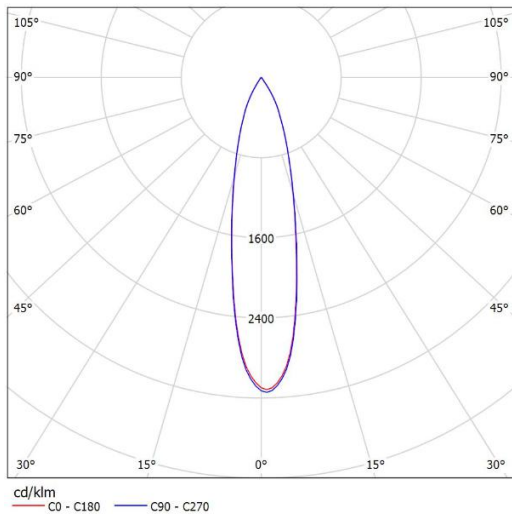

SL-07526B
K:3.77cd/lm,LED:V15

Distribution Curve Flux

SL-075B&SL-CXM-18-HD-A

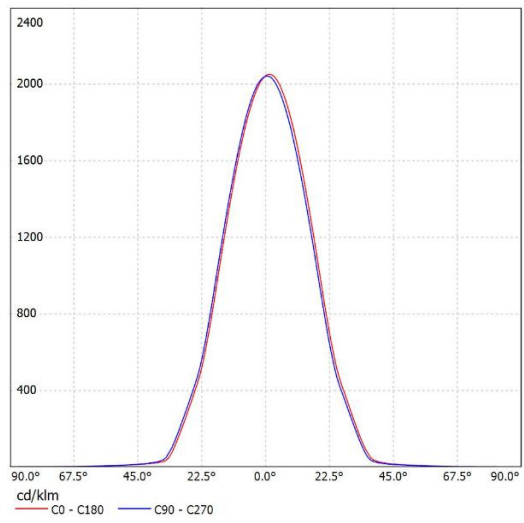
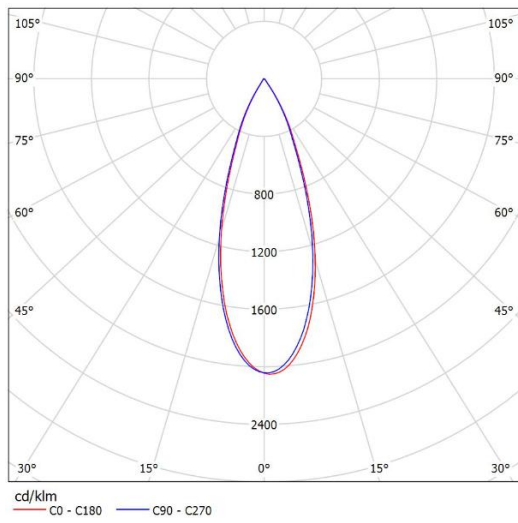

SL-07538B
K:2.54cd/Im,LED:V15

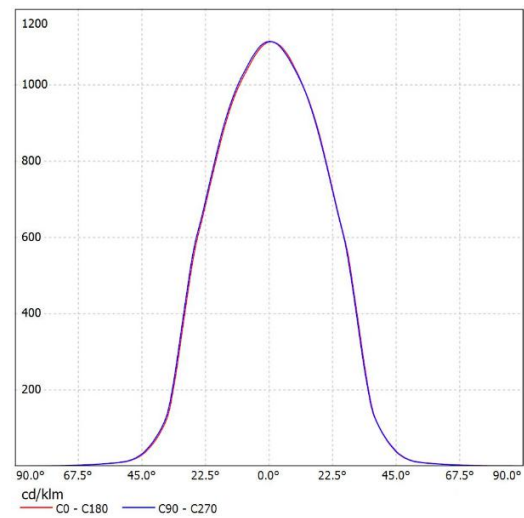
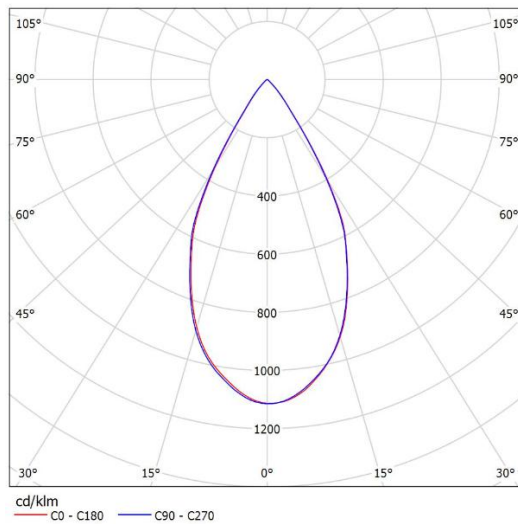

SL-07555B
K:1.38cd/Im,LED:V15

Package Description

SL-075B

Part NO.	Without pc cover		With pc cover		Box Size(cm)
	Number per Box (pcs)	Box Weigh(kg)	Number per Box (pcs)	Box Weigh(kg)	
SL-07518B	252	6.65	224	7.33	60 X 37 X45
SL-07526B	252	6.93	224	7.73	60 X 37 X45
SL-07538B	252	6.95	224	7.73	60 X 37 X45
SL-07555B	252	7.88	224	8.58	60 X 37 X45

Notes

- It is not allowed to scrub the reflective surface. If there is dust on the surface, please clean by soft cotton with little water.
 - It is forbidden to clean with industrial solvent such as ethanol.
 - Storage temperature: 0°C-40°C, and humidity:30%-95%
 - Keep reflectors in package to void the dust.
 - Prohibit the reflector touch with acid or alkaline solvent
-

About Shinland

Shenzhen Shinland Co. Ltd,one of the longest and most professional company in lighting optical field,have 20 years experience.Different from other factory which only have simple process, all aspects included R&D,making mold,injection molding ,vacuum coating and market support are our company own vertically integrated production .

Insisting on 'Quality First, Service First' and pragmatic, enterprising spirit,building the market by quality, casting our brand by credibility and integrity ,Shinland now become the leading supplier of lighting optical solution in China.